

Assembly Instruction

Step 4

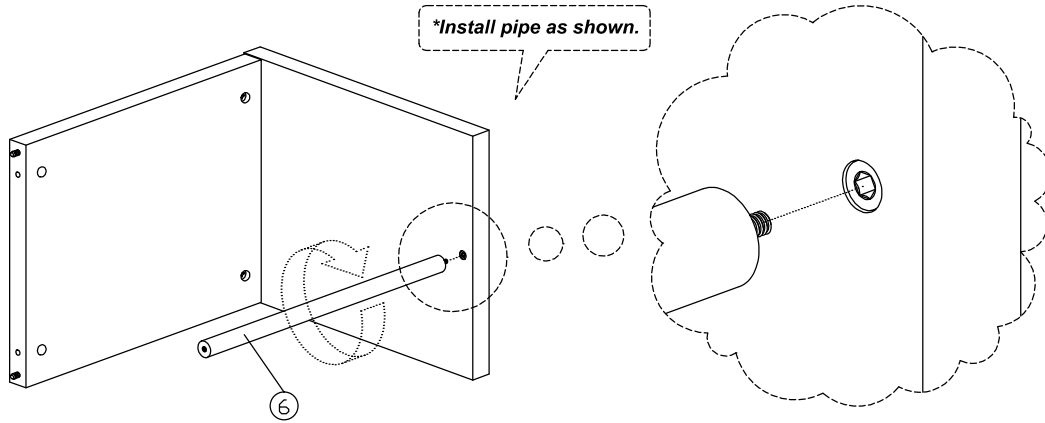

Step 5

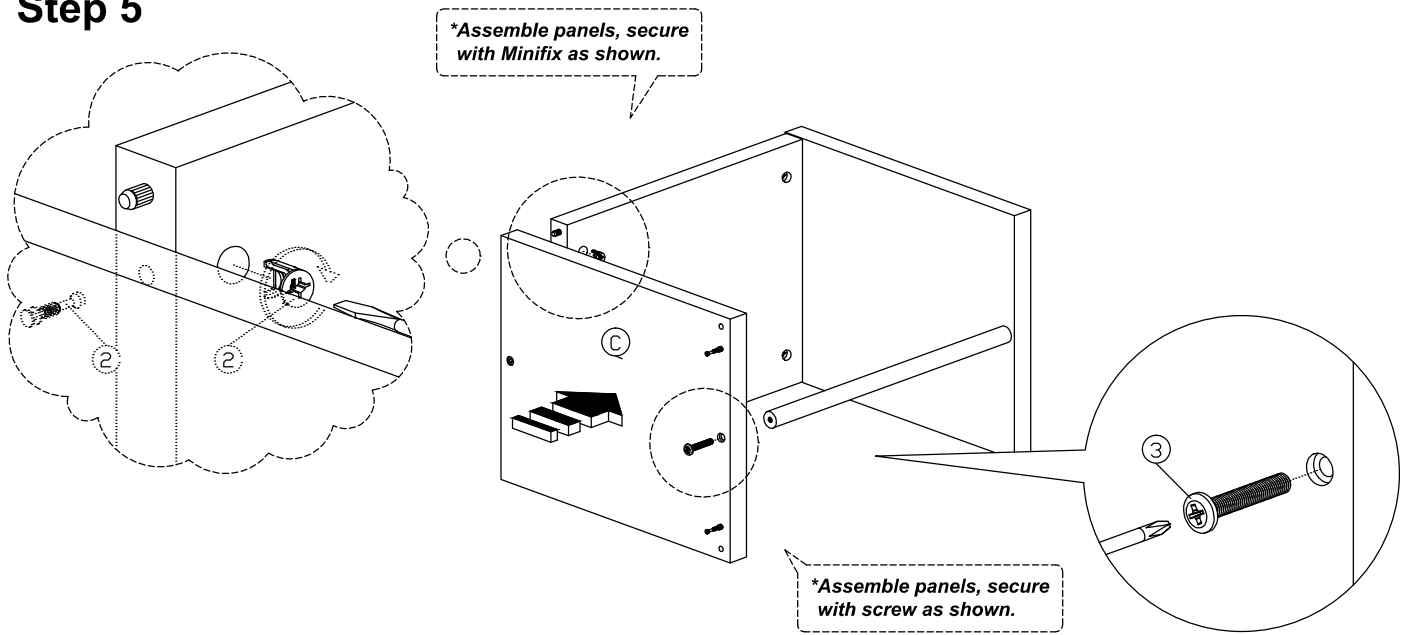

Step 6

